

CONTROLLED

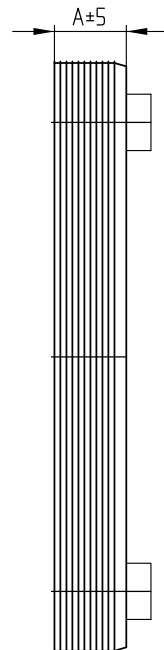

Q1-Q2
L1(W210)
Screw-Thread Connection

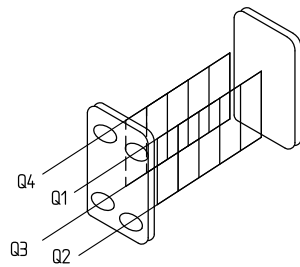
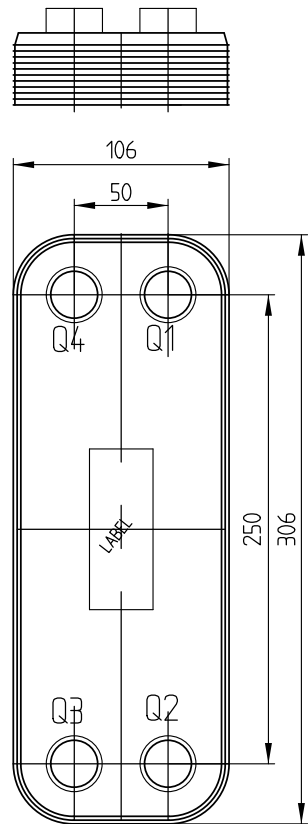
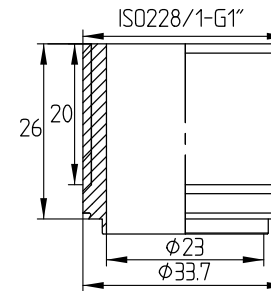

Q3-Q4
H1"1/8(H2116)
Welded Connection

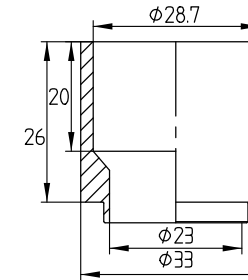

ID	RIDAN Code	Drawing No.	Model	Plates(n)	A	WEIGHT	VOLUME
1	021B8725R	2305501-01	027	22	61	3.59Kg	Q1Q2:0.627L/Q3Q4:0.57L
2	021B8726R	2305501-02	027	24	66	3.8Kg	Q1Q2:0.684L/Q3Q4:0.627L
3	021B8727R	2305501-03	027	26	70	4Kg	Q1Q2:0.741L/Q3Q4:0.684L
4	021B8728R	2305501-04	027	30	80	4.42Kg	Q1Q2:0.855L/Q3Q4:0.798L
5	021B8729R	2305501-05	027	32	84	4.63Kg	Q1Q2:0.912L/Q3Q4:0.855L
6	021B8730R	2305501-06	027	34	89	4.84Kg	Q1Q2:0.969L/Q3Q4:0.912L
7	021B8731R	2305501-07	027	40	103	5.46Kg	Q1Q2:1.14L/Q3Q4:1.083L
8	021B8732R	2305501-08	027	50	125	6.5Kg	Q1Q2:1.425L/Q3Q4:1.368L
9	021B8733R	2305501-09	027	60	148	7.54Kg	Q1Q2:1.71L/Q3Q4:1.653L
10	021B8734R	2305501-10	027	70	171	8.58Kg	Q1Q2:1.995L/Q3Q4:1.938L

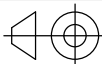
		DESIGN DATA			
DESIGN PRESSURE		3.0MPa			
TEST PRESSURE		4.5MPa			
DESIGN TEMPERATURE		-196/+225			
LEAKAGE TEST		Helium Test			
PLATE MATERIAL		316L			
PIPE MATERIAL		304			
FRAME MATERIAL		304			
Assembly drawing	DEPARTMENT	Sales	DATE	SCALE	 DESIGNATION RD-027-n-3.0-H- Q1Q2(L1)/Q3Q4(H1"1/8)
	DESIGNER	JLN	2022/05/06		
	INSPECTOR	ZJF	2022/05/06		
	APPROVAL	FL	2022/05/06		
DRAWING NO.		2305501		REV 0	