

①

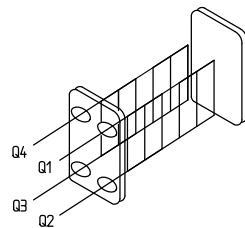

①

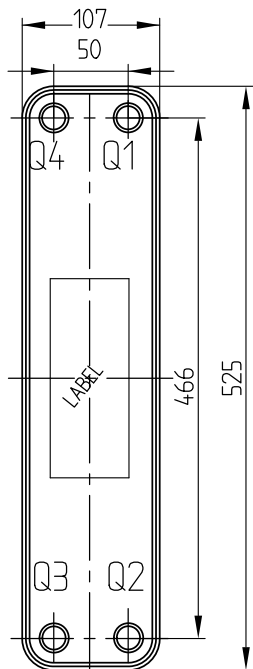
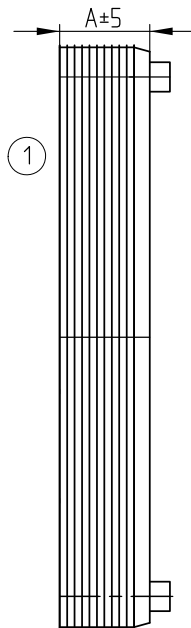

Q1-Q2-Q4
H1"1/8(H2116)
Welded Connection

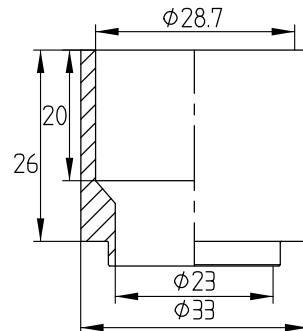

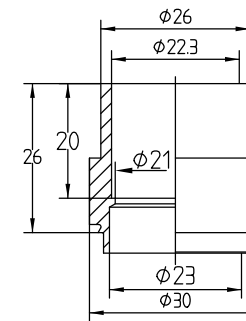

Q3
H7/8"(H2075)
Welded Connection



ID	RIDAN Code	Drawing No.	Model	Plates(n)	A	WEIGHT	VOLUME
1	021H9540R	2306376	052	20	56	5.7Kg	Q1Q2:0.97L/Q3Q4:0.873L

DESIGN DATA	
DESIGN PRESSURE	3.0MPa
TEST PRESSURE	4.5MPa
DESIGN TEMPERATURE	-196/+225
LEAKAGE TEST	Helium Test
PLATE MATERIAL	316L
PIPE MATERIAL	304
FRAME MATERIAL	304

Assembly drawing	DEPARTMENT	Sales	DATE	SCALE	 DESIGNATION RD-052-20-3.0-HQ-Q1Q2Q4(H1"1/8)/Q3(H7/8")
	DESIGNER	JLN	2022/06/14		
	INSPECTOR	ZJF	2022/06/14		
	APPROVAL	FL	2022/06/14		
DRAWING NO.		2306376		REV	1

Version	Change date	Description	State	Designer
1	2022/06/20	Remove bolts from unit drawing	①	JLN