

CONTROLLED

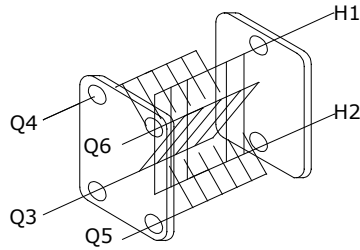

Q3-Q5
H1"1/8(H4114)
Solder connection

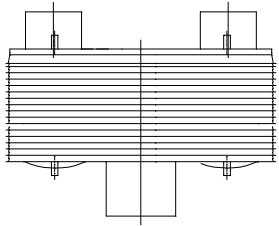
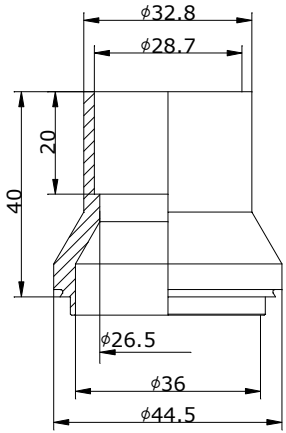

Q4-Q6
H1"3/8(H4138)
Solder connection

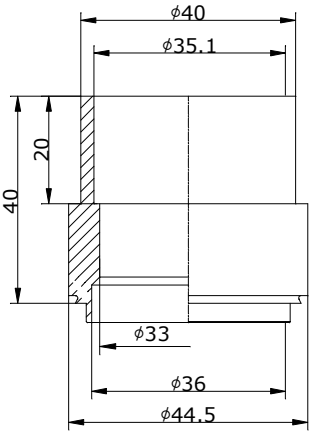

H1-H2
T88,9(LJ830)
Victaulic connectoin

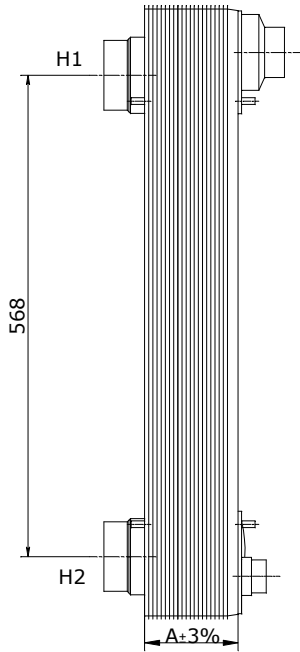
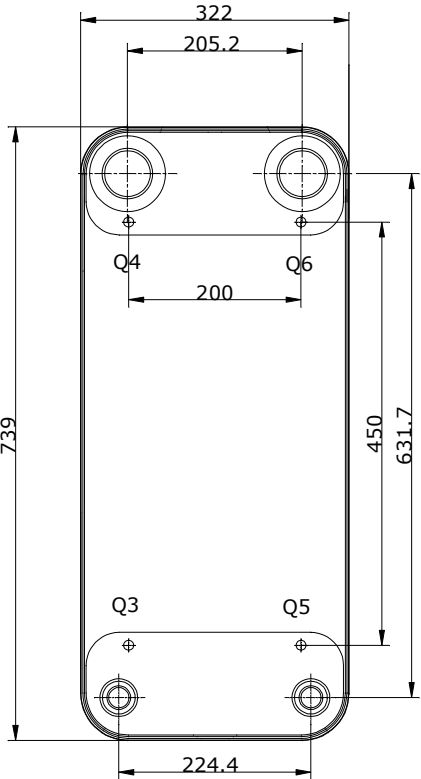
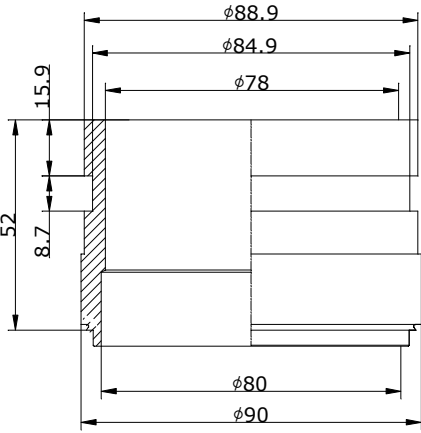

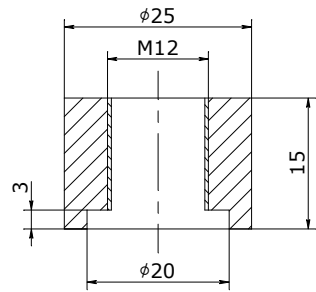

Nuts for mounting bolts



Note: 8-M12X40 bolts

ID	RIDAN Code	Drawing No.	Model	Plates(n)	A	Weight	Volume
1	111B0317R	23021365-01	210	154	410	128.806Kg	Q3Q5Q4Q6:19L/H1H2:38.5L

		DESIGN DATA			
DESIGN PRESSURE		4.5MPa			
TEST PRESSURE		6.75MPa			
DESIGN TEMPERATURE		-196/+225			
LEAKAGE TEST		Helium Test			
PLATE MATERIAL		316L			
PIPE MATERIAL		304			
FRAME MATERIAL		304			
Assembly drawing	DEPARTMENT	Sales Department	DATE	SCALE	 RD-210-154-4,5-HDQ-Q3Q5 (H1"1/8)/Q4Q6(H1"3/8)/ H1H2(T88,9)/8-M12x40 DESIGNATION:
	DESIGNER	JLN	2024/08/28		
	INSPECTOR	ZJF			
	APPROVAL	FL			
DRAWING NO.		230213065-01		REV. 0	